

4 WATCH A RECORDED PROGRAM

* You can use both the buttons on the Remote and on the VCR.

- 1 Load a cassette with the label facing out and the window facing up.
- 2 Find program start point.
Remote: Press **REW** or **FF**.
VCR: Turn **SHUTTLE** to the left or to the right.
- 3 Press **PLAY** to start playback.

To stop play, press **STOP** (Remote) or **STOP/EJECT** (VCR)

To eject the cassette, press **STOP/EJECT** (VCR) after stopping play.

5 RECORD A PROGRAM

a-BASIC RECORDING

* You can use both the buttons on the Remote and on the VCR.

- 1 Load a cassette as above.
- 2 Select the recording channel.
Remote: Press **CH + /-** or press the appropriate **Number** keys then press **ENTER**.
VCR: Press **CH ▲▼**.
- 3 Press **SP/EP** to set the recording speed.
- 4 Start recording.
Remote: Press **REC** and **PLAY** together.
VCR: Press **REC**.

To stop recording temporarily, press **PAUSE**. To resume recording, press **PLAY**.

To stop play, press **STOP** (Remote) or **STOP/EJECT** (VCR).

To eject the cassette, press **STOP/EJECT** (VCR) after stopping recording.

b-INSTANT TIMER RECORDING

* You can perform ITR only using the button on the VCR.

- 1 Press **REC** to start recording.
- 2 Press **REC** to engage ITR. "0:30" appears on the front panel display.
- 3 To extend duration in increments of 30 minutes, press **REC** as many times as necessary.

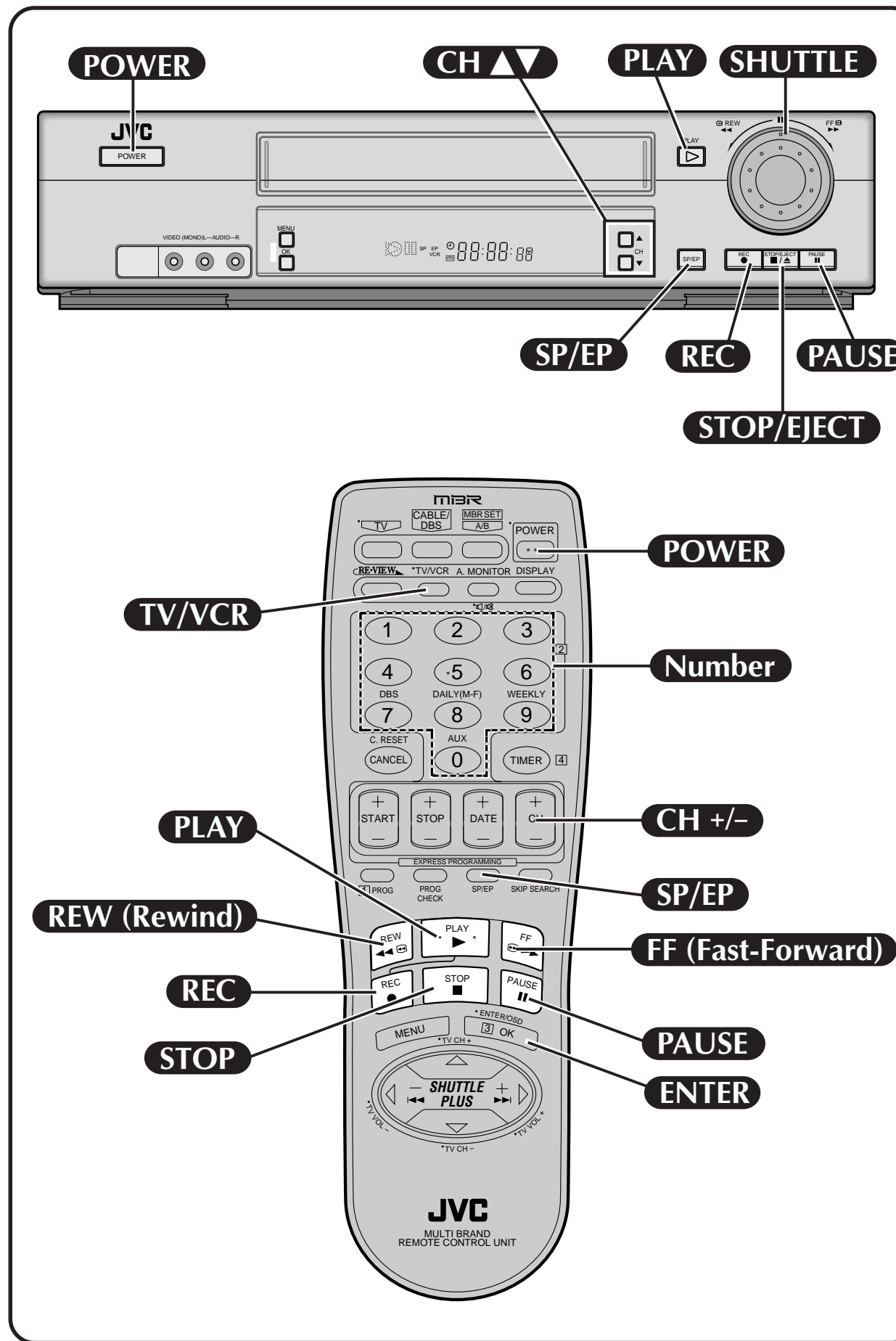
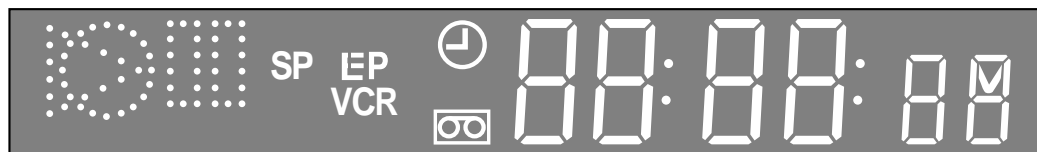

Dear Customer,
Thank you for purchasing
this JVC Video Cassette
Recorder.

QUICK START*

A GUIDE TO EASY SET UP AND USE

JVC

MONO/Hi-Fi/SUPER VHS
VIDEO CASSETTE RECORDERS

* Please refer to the HR-VP782U's instruction manual for more detailed information.

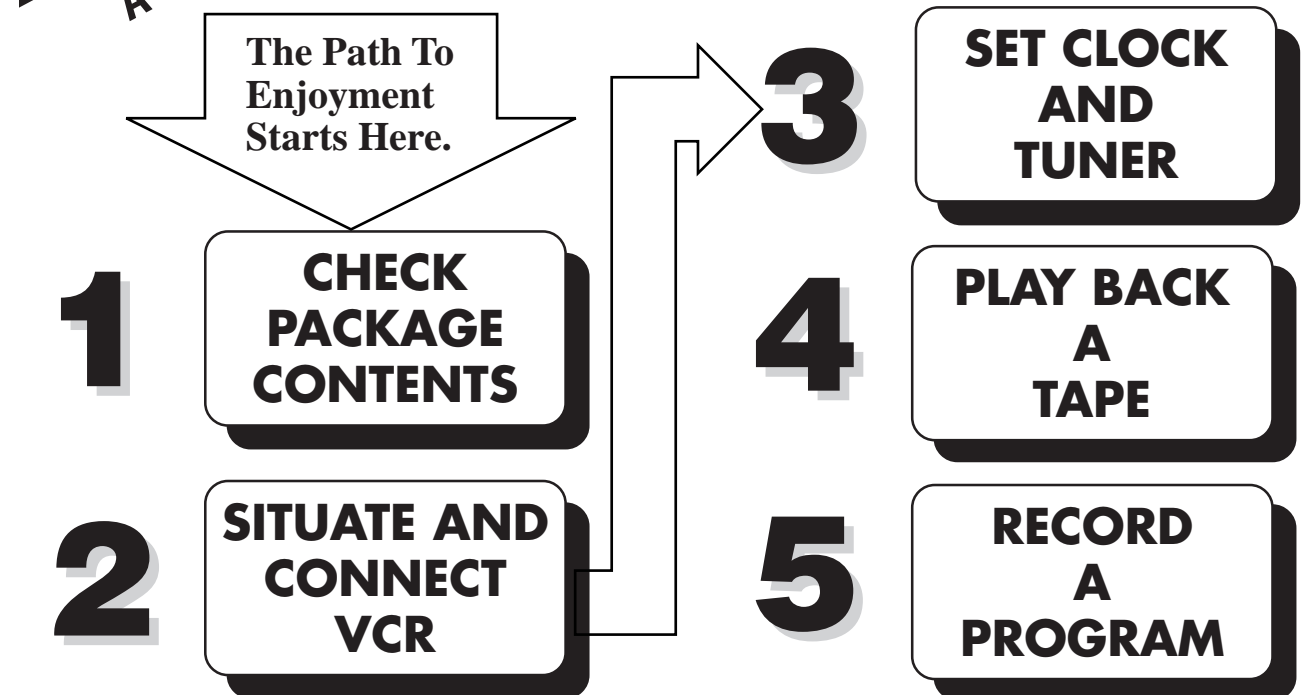

1 MAKE SURE THAT YOUR PACKAGE CONTAINS:

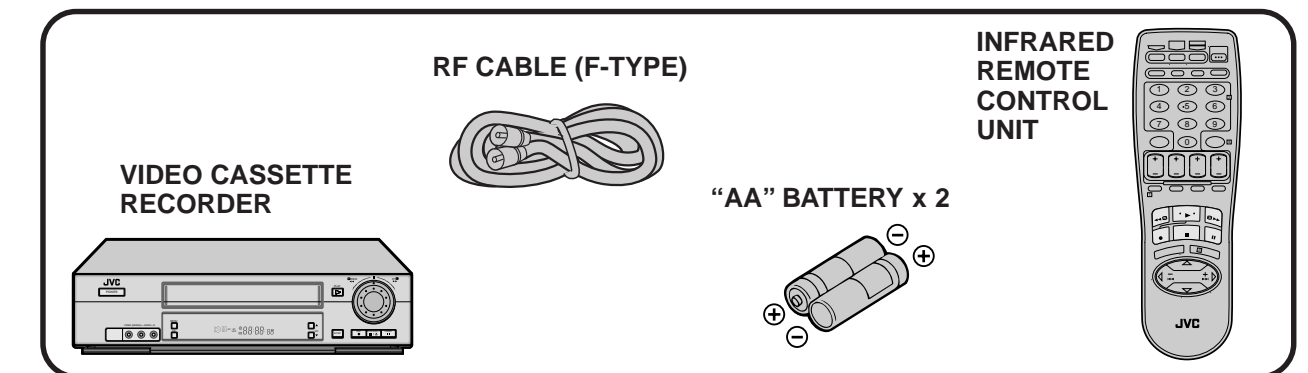

Printed in Malaysia
1199 IYV*MM*PJ

COPYRIGHT © 1999 VICTOR COMPANY OF JAPAN, LTD.

LPT0347-002A

2 SITUATE AND CONNECT YOUR NEW VCR

a-BASIC ANTENNA/CABLE CONNECTION

- ① Place the VCR on a stable, horizontal surface.
- ② Disconnect your antenna or cable line from your TV.
- ③ Connect your antenna to your VCR.
- ④ Connect your VCR to your TV.
- ⑤ After completing the basic connections:
 - If you're using a Cable Box, . . . go to **2b** (CATV CONVERTER CONNECTION).
 - If you're using an AV connection, . . . go to **2c** (AUDIO/VIDEO CONNECTIONS).
 - If you're using an RF connection only, . . . go directly to **3** (PLUG & PLAY).

RF CONNECTION

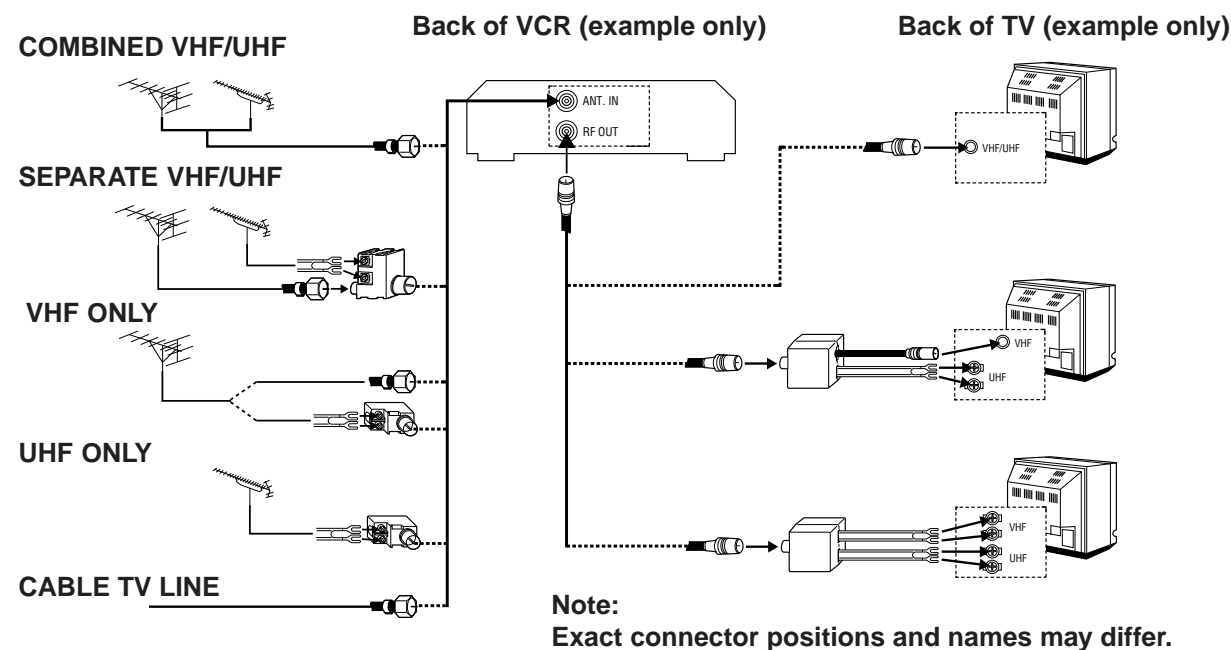

CONNECTORS WHICH ARE OR MAY BE REQUIRED:

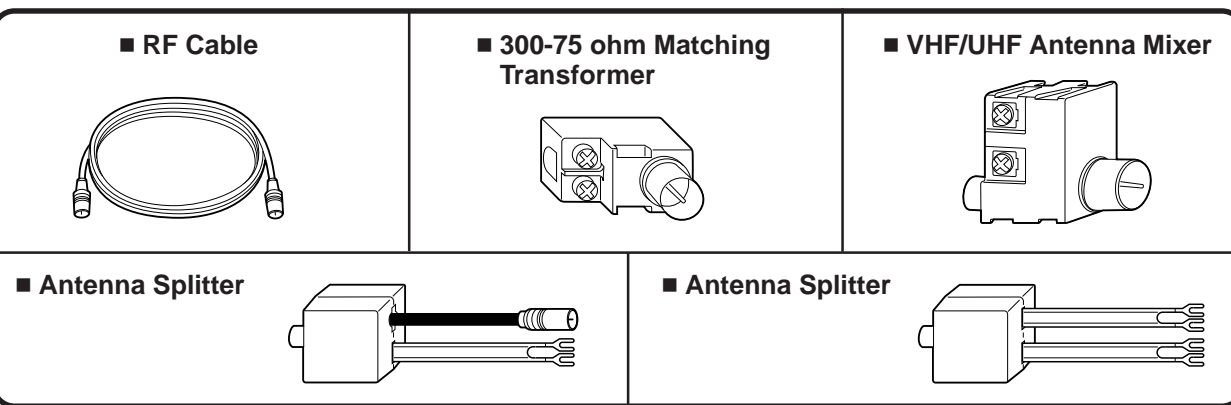

b-CATV CONVERTER CONNECTION

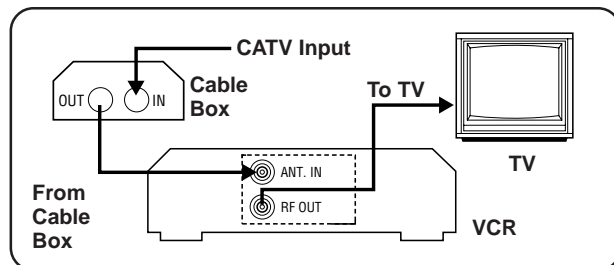

With this connection you can view/record any cable channel including scrambled channels to which you have subscribed.

To watch TV with this type of connection

- ① Press **TV/VCR** on the Remote so that the VCR mode indicator lights on the front display panel.
- ② Tune TV to VCR output channel (3, 4 or AV mode).
- ③ Tune VCR to Cable Box output channel.
- ④ Select desired channel on Cable Box.
 - You can only view the channel you are recording.

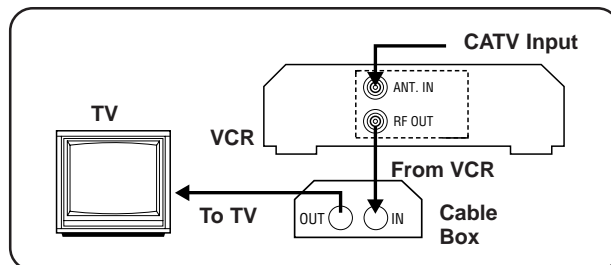

With this connection, you can view one scrambled cable channel while recording another unscrambled channel.

To watch TV with this type of connection

- ① Press **CH ▲▼ (+/-)** or **Number** keys to select desired channel for recording.
- ② Press **TV/VCR** so that the VCR mode indicator goes off from the front display panel.
- ③ Tune TV to Cable Box output channel.
- ④ Select desired channel on Cable Box.
 - You cannot record scrambled channels.
 - To play back a tape, you must tune the Cable Box to the VCR output channel.

c-AUDIO/VIDEO CONNECTIONS

AV connection methods differ from one type of VCR to another. First, for any TV and VCR, connect your VCR to your TV using RF connection. Then make AV connections following one of the methods illustrated here. After making the connections, go to **3** (PLUG & PLAY).

Hi-Fi VHS VCR → AV STEREO TV

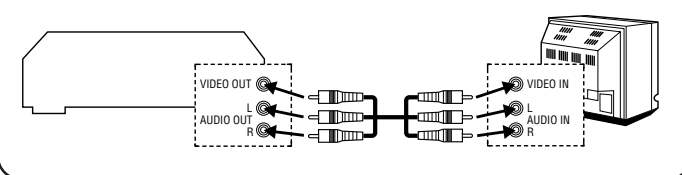

MONAURAL VHS VCR → AV TV

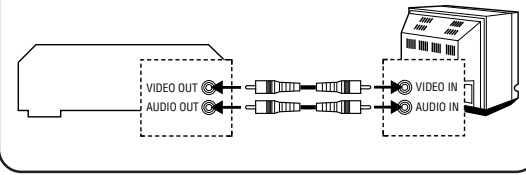

SUPER VHS VCR → AV STEREO TV WITH S-VIDEO INPUT TERMINALS

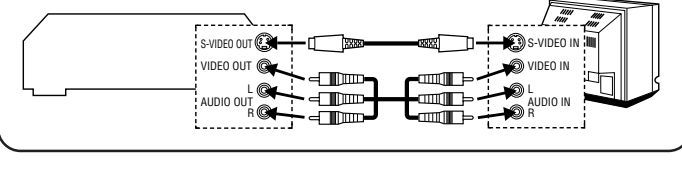

To Listen To VCR Sound Through A Component Stereo Audio System, Connect As Shown

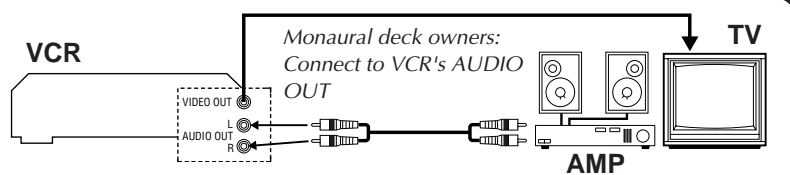

3 SET YOUR VCR'S CLOCK AND TUNER

PLUG & PLAY

The VCR's clock and tuner channels are set automatically when the VCR is plugged into the AC outlet. If you use a cable box, Plug & Play will not function; set the clock and tuner channels separately. (pg.10 - 14 of the HR-VP782U's instruction manual)

- 1 Plug the VCR into the AC outlet.

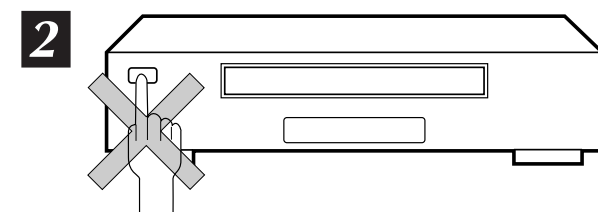

Do not press any buttons on the VCR or on the Remote during Auto Setup.

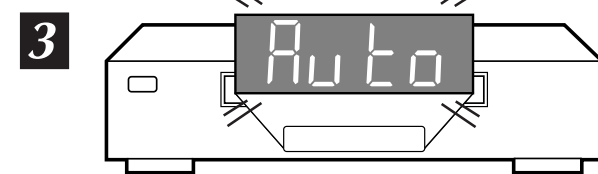

"AUTO" blinks while the VCR automatically sets the clock using information provided by the local PBS channel.

NOTES:

- If the clock time displayed in **5** is incorrect, perform the Semiauto or Manual Clock Set procedure (refer to page 11 or 12 of the HR-VP782U's instruction manual). Auto Channel Set has already taken place, and is not affected.
- There are some PBS channels that do not transmit clock setting data. If your antenna cable is properly connected and "-- : --" is displayed, perform the Manual Clock Set procedure (refer to page 12 of the HR-VP782U's instruction manual). Auto channel setting has not yet taken place, so perform the Auto Channel Set procedure (refer to page 13 of the HR-VP782U's instruction manual).

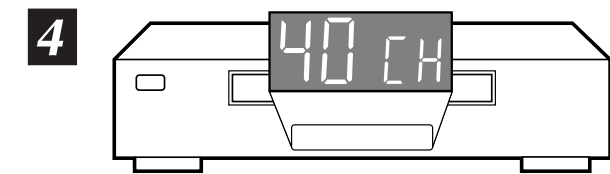

During Auto Channel Set, the channel numbers are displayed as they are scanned and set. Receivable channels are automatically stored in memory in the order of their frequencies, and non-receivable channels are skipped.

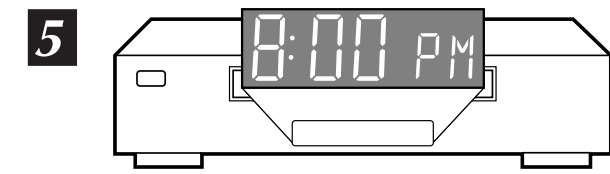

When setting is complete, the VCR displays the current clock time. You can now use your VCR.